

ASI / TSoIP (Ethernet) Network Interface Adapter



# User Manual



**Table of Contents:**

Section	Page
Revision History	2
Operational Safety	4
openGear® Introduction	4
General Description	5
Technical Specifications	6
Configuration	7
DIP Switch Settings	7
DIP Switch ASI to TSoIP Transmitter Mode Quick Setup Guide	8
DIP Switch TSoIP to ASI Receiver Mode Quick Setup Guide	8
Installation	9
ASI Signal Connection	9
Ethernet Connection	9
Front Edge Switch & LED Locations	10
Rear Assembly Layout	11
Operation	12
ASI to TSoIP Converter Description of Operation	12
TSoIP to ASI Converter Description of Operation	12
LED Indicators	13
ASI to TSoIP Converter LED Description	13
TSoIP to ASI Converter LED Description	13
DIP Switch Control	13
Software Control	14
DashBoard™ Software Control	15
IRT-6750-MEM DashBoard™ Screenshots	15
Basic Tree View	15
Product TAB	15
Config TAB	16
ASI to TSoIP TAB	17
TSoIP to ASI TAB	18
SNMP Software Control	19
IRT-6750-MEM SNMP Functions	19
Maintenance & Storage	22
Warranty & Service	22

This instruction book applies to units fitted with firmware ≥ Revision 1.1

### **WARNING**

Operation of electronic equipment involves the use of voltages and currents that may be dangerous to human life. Note that under certain conditions dangerous potentials may exist in some circuits when power controls are in the **OFF** position. Maintenance personnel should observe all safety regulations.

Do not make any adjustments inside equipment with power **ON** unless proper precautions are observed. All internal adjustments should only be made by suitably qualified personnel. All operational adjustments are available externally without the need for removing covers or use of extender cards.

## openGear® INTRODUCTION

---

Developed by Ross Video, openGear® is a standard where various manufacturers can design their equipment to fit a common frame allowing the end user to mix and match the various openGear® cards available in the marketplace together in one frame. This allows a single frame to be used instead of multiple different vendor's frames that each would otherwise be using their own proprietary standard.

A simple to use monitoring and control software called DashBoard™ is a free program downloadable from the openGear® website ([www.opengear.tv](http://www.opengear.tv)) that allows the user to remotely monitor and control an openGear® type card fitted within an openGear® frame that meets the openGear® standard for DashBoard™ control. A link is also supplied via the I.R.T. Communications website ([www.irtcommunications.com](http://www.irtcommunications.com)) under the openGear® navigation section.

I.R.T. Communications' openGear® cards are designed to meet the openGear® standard for mounting within the openGear® OG3-FR frame and its earlier version DFR-8300 frame, and is fully compliant with DashBoard™ control.

The openGear® frame manual, DashBoard™ control software and information regarding the frame's power supplies, controller card and frame accessories are available for download at the openGear® website.

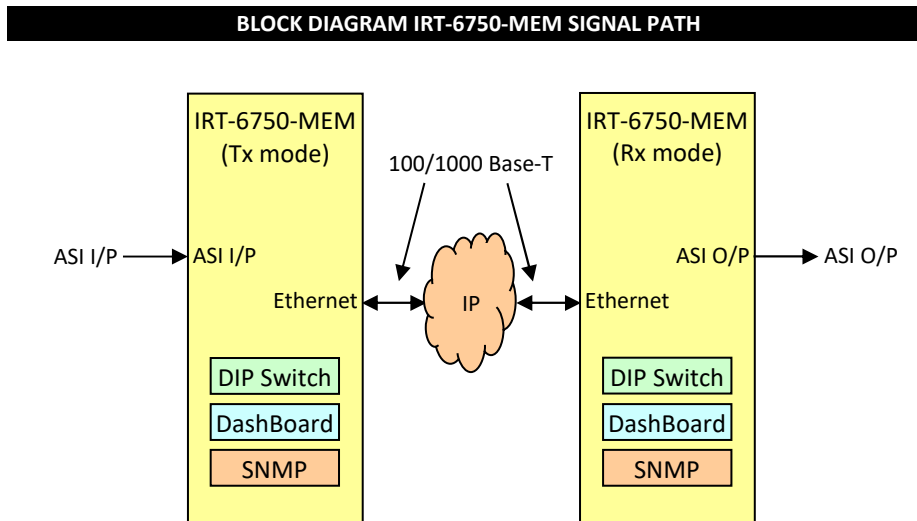

The IRT-6750-MEM is a Transport Stream over Internet Protocol (TSoIP) converter that acts as a gateway between an ASI and an Ethernet network environment.

The IRT-6750-MEM is designed to operate independently as either a transmitter (ASI to TSoIP) or receiver (TSoIP to ASI) or can be used as a pair with one unit at each end of an Ethernet link.

When configured as an ASI to TSoIP converter (transmitter mode), the input ASI stream is encapsulated into either UDP or RTP Ethernet packets with controlled scheduling of IP packets to prevent IP jitter. Forward error correction (FEC) in accordance to SMPTE 2022-1 can also be added to the conversion when in RTP mode.

An interesting application for the transmitter mode is for visual monitoring of the ASI stream's content on an Ethernet link by third party software, such as by VideoLAN's VLC media player (for a single content ASI stream) downloadable as a free download from the internet.

When configured as a TSoIP to ASI converter (receiver mode), the IRT-6750-MEM accepts unicast and multicast IP streams over its Gigabit Ethernet port. The UDP or RTP packets are de-encapsulated with IP jitter removal and error correction applied as per SMPTE 2022-1. The resultant output being either a 188 or 204 byte (settable) ASI signal.

The Ethernet port has automatic MDI/MDI-X detection, this detects whether the Ethernet interconnect cable is a straight through or cross over type and automatically switches itself to accommodate, and will automatically select the link speed of the connected network (100/1000Mb/s).

All parameters are set via a preset range of DIP switch settings, or set and read via openGear's DashBoard™ software control program, or via a Simple Network Management Protocol (SNMP) system.

The IRT-6750-MEM is designed to fit the openGear® standard 2RU frames which allow a mixture of cards from various manufacturers to be mounted within the same frame.

The DashBoard™ control software is available as a free download.

### Standard features:

- **ASI to TSoIP, or TSoIP to ASI conversion.**
- **Set up as either transmitter or receiver.**
- **Supports enabling of Forward Error Correction (FEC).**
- **IP de-jittering.**
- **UDP or RTP encapsulation.**
- **DIP switch, DashBoard™ or SNMP software monitoring and control.**

## TECHNICAL SPECIFICATIONS

### Input/Output:

Type	1 x ASI, BNC connector.
Transport Stream Bit Rate	0.01 to 214 Mb/s.
Packet Size	188/204.
Impedance	75 Ohm.
Return Loss	> 15 dB @ 270 MHz.
Equalisation	> 250 metres at 270 Mb/s for Belden 8281 or equivalent cable.

### Ethernet:

Type	Standard IEEE 802.3a.
Data Rate	100 Mb/s or 1 Gb/s, automatic.
Connector	RJ-45.
Ethernet Encapsulation	IEEE 802.2 SNAP and Ethernet II.
IP Support	IPv4.
IP Address Assignment	DHCP, DIP switch local or static.
Multicast Support	IGMP v2.

### Transport Stream Input/Output over IP:

TSoIP Encapsulation	UDP or SMPTE 2022-2.
Input-to-IP Delay	≤ 1 ms.
IP-to-Output Delay	1 to 120 <sup>1</sup> ms (programmable).
IP Input Jitter Tolerance	1 to 120 <sup>2</sup> ms (computed).

### UDP:

TS Packet Size	188 or 204 bytes.
TS Packets per IP Packet	1 to 7.

### SMPTE 2022-2:

Transport Protocol	RTP.
Forward Error Correction (FEC)	SMPTE 2022-1.
Packet Size	188 or 204 bytes.
TS Packets per IP Packet	1 to 7.
FEC Size L	1 to 20.
FEC Size D	4 to 20.
FEC Size LxD	4 to 100.

### Power Requirements:

Voltage	+ 12 Vdc.
Power consumption	< 5 VA.

### Other:

Temperature range	0 - 50° C ambient.
Mechanical	Suitable for mounting in an openGear® 2RU rack chassis.
Dimensions (openGear® standard)	33.6 mm x 2U x 325 mm;

Supplied accessories Rear assembly.

Ordering IRT-6750-MEM IRT-6750-MEM, programmed with DashBoard™ control.

**NOTE:** 1 Maximum delay depends on input bit rate and number of TS packets per IP packet.  
2 Maximum jitter tolerance depends on programmed IP-to-output delay and on FEC delay.

## CONFIGURATION

### DIP Switch settings:

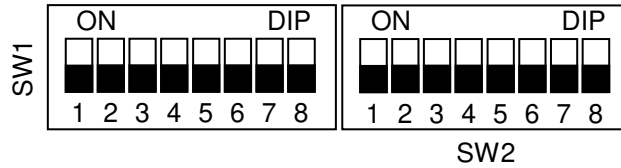

**SW1-1** OFF DIP switch control.  
ON Software control via Dashboard™ or SNMP.

Card IP Address	SW1-2	SW1-3	SW1-4
192.168.1.200	OFF	OFF	OFF
192.168.1.201	OFF	OFF	ON
192.168.1.202	OFF	ON	OFF
192.168.1.203	OFF	ON	ON
192.168.1.204	ON	OFF	OFF
192.168.1.205	ON	OFF	ON
192.168.1.206	ON	ON	OFF
192.168.1.207	ON	ON	ON

**SW1-5** OFF ASI to TSoIP Transmitter mode.  
ON TSoIP to ASI Receiver mode.

Destination IP Address <sup>3</sup>	SW1-6	SW1-7	SW1-8
192.168.1.200	OFF	OFF	OFF
192.168.1.201	OFF	OFF	ON
192.168.1.202	OFF	ON	OFF
192.168.1.203	OFF	ON	ON
192.168.1.204	ON	OFF	OFF
192.168.1.205	ON	OFF	ON
192.168.1.206	ON	ON	OFF
192.168.1.207	ON	ON	ON

UDP Port <sup>4</sup>	SW2-1	SW2-2	SW2-3
8000	OFF	OFF	OFF
8001	OFF	OFF	ON
8002	OFF	ON	OFF
8003	OFF	ON	ON
8004	ON	OFF	OFF
8005	ON	OFF	ON
8006	ON	ON	OFF
8007	ON	ON	ON

Transport Packets per IP <sup>3</sup>	SW2-4	SW2-5	SW2-6
1	OFF	OFF	OFF
1	OFF	OFF	ON
2	OFF	ON	OFF
3	OFF	ON	ON
4	ON	OFF	OFF
5	ON	OFF	ON
6	ON	ON	OFF
7	ON	ON	ON

	For Transmitter mode (ASI to Ethernet)	For Receiver mode (Ethernet to ASI)
<b>SW2-7</b> OFF	UDP.	Set packet size as per SW2-8.
ON	RTP.	Use incoming packet size.

**SW2-8** OFF 188 byte packet size.  
ON 204 byte packet size.

- NOTE: 3** Not applicable to Receiver mode of operation (Ethernet to ASI).  
**4** To UPD Port for Transmitter mode; From UDP Port for Receiver mode.

## DIP Switch ASI to TSoIP Transmitter Mode Quick Setup Guide:

- SW1-1** OFF DIP switch control.
- SW1-2** ] Card IP Address:  
**SW1-3** ] choice of 192.168.1.200 to 192.168.1.207  
**SW1-4** ] as per Configuration Table in *Configuration* section of this manual.
- SW1-5** OFF ASI to TSoIP Transmitter Mode.
- SW1-6** ] Destination IP Address:  
**SW1-7** ] choice of 192.168.1.200 to 192.168.1.207  
**SW1-8** ] as per Configuration Table in *Configuration* section of this manual.
- SW2-1** ] To UDP port number:  
**SW2-2** ] choice of 8000 to 8007  
**SW2-3** ] as per Configuration Table in *Configuration* section of this manual.
- SW2-4** ] Number of Transport Packets per IP Stream:  
**SW2-5** ] choice of 1 to 7  
**SW2-6** ] as per Configuration Table in *Configuration* section of this manual.
- SW2-7** OFF UDP. ] Set TSoIP output protocol.  
ON RTP. ]
- SW2-8** OFF 188. ] Set packet size within TSoIP stream.  
ON 204. ]

## DIP Switch TSoIP to ASI Receiver Mode Quick Setup Guide:

- SW1-1** OFF DIP switch control.
- SW1-2** ] Card IP Address:  
**SW1-3** ] choice of 192.168.1.200 to 192.168.1.207  
**SW1-4** ] as per Configuration Table in *Configuration* section of this manual.
- SW1-5** ON TSoIP to ASI Receiver Mode.
- SW1-6** ]  
**SW1-7** ] Not applicable to TSoIP to ASI Receiver mode.  
**SW1-8** ]
- SW2-1** ] From UDP port number:  
**SW2-2** ] choice of 8000 to 8007  
**SW2-3** ] as per Configuration Table in *Configuration* section of this manual.
- SW2-4** ]  
**SW2-5** ] Not applicable to TSoIP to ASI Receiver mode.  
**SW2-6** ]
- SW2-7** OFF Set ASI output packet size to match that of SW2-8 setting.  
ON Set ASI output packet size to match that of incoming packet size.
- SW2-8** OFF 188. ] Set packet size of ASI output stream if SW2-7 is OFF.  
ON 204. ] Not applicable if SW2-8 is ON.



## INSTALLATION

### Pre-installation:

#### Handling:

This equipment may contain or be connected to static sensitive devices and proper static free handling precautions should be observed.

Where individual circuit cards are stored, they should be placed in antistatic bags. Proper antistatic procedures should be followed when inserting or removing cards from these bags.

#### Installation in openGear® frame:

See details in separate manual downloadable from the openGear® website ([www.opengear.tv](http://www.opengear.tv)).

#### ASI Signal Connection:

With the IRT-6750-MEM mounted in the card, on the rear assembly is a single 75 Ω BNC connector that is used as either an ASI input or an ASI output depending on how the IRT-6750-MEM card has been set up, either as an ASI to TSoIP converter or a TSoIP to ASI converter.

The source or load equipment must be of 75 Ω impedance. Input cable equalisation is automatic for up to 250m of high quality 75Ω coaxial cable (Belden 8281 or equivalent). ASI transport stream bitrates are rated from 0.01 to 214Mb/s, 188 or 204 bytes in length.

#### Ethernet Connection:

The Ethernet connection plugs directly into the main board of the IRT-6750-MEM via the rear assembly. Care must be taken when removing the card with either enough length of the Ethernet cable to be able to pass fully through the frame, or removal of the Ethernet cable first, else damage to the board may result.

Connection is via a standard RJ-45 type of Cat-5 or Cat-6 Ethernet cable with either a data rate of 100/1000 Base-T. Either a straight through or cross over network cable can be used; the type of cable will be automatically recognized (auto MDIX operation) as well as the link speed of the connected network.

Two status LEDs on the RJ-45 connector indicate link activity and link speed. The link activity LED flashes whenever an Ethernet packet is received or transmitted. The link speed LED illuminates green when a 100 Base-T signal is present, and orange when a 1000 Base-T (Gig-E) signal is present.

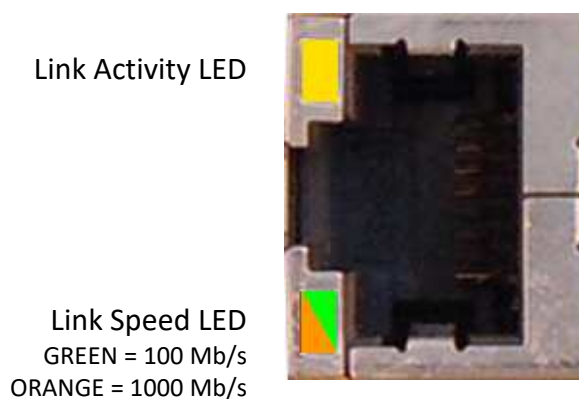

## Front Edge Switch & LED Locations

Green/Red LED: GREEN – Communication with frame’s Network card.  
 RED - No communication with Network card / No Network card.



Connection to sub-board:  
 GREEN – connected;  
 RED – not connected.

**ASI to TSolP mode:**  
**LED1:** GREEN - Valid ASI detected;  
 RED – Invalid or no ASI detected.  
**LED2:** GREEN – IP parameters ok;  
 RED – IP parameters not ok;  
 RED FLASH – ASI to TSolP disabled.

**TSolP to ASI mode:**  
**LED1:** GREEN - ASI O/P ok;  
 OFF – No ASI output.  
**LED2:** GREEN – No IP parameter errors detected;  
 RED – IP parameter errors detected or there is a problem with  
 processing of IP stream;  
 RED FLASH – TSolP to ASI disabled.

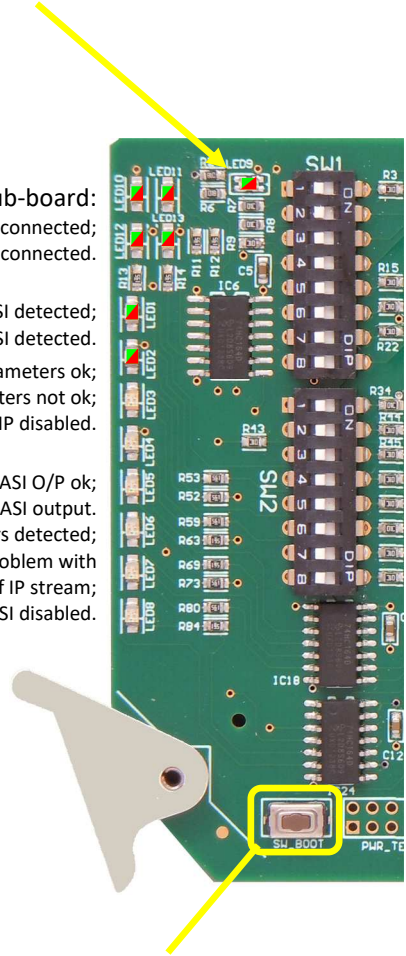

SW\_boot switch: Default Reset Switch.  
 User set names and switch position are stored within memory so that in the event of a loss of power this information is restored on resumption of power.

If the default Reset Switch is pressed whilst powering or inserting the card, the IRT-6750-MEM will default to factory preset condition.

## Rear Assembly Layout

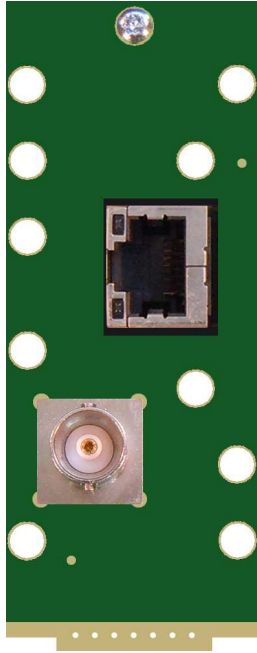

Standard  
Rear Assembly

NOTE: Ethernet connector mounted directly on main board.

## OPERATION

---

The IRT-6750-MEM can be configured as either an ASI to TSoIP or a TSoIP to ASI converter where TSoIP stands for Transport Stream over Internet Protocol, which is essentially an Ethernet connection at either a 100 Base-T or 1000 Base-T data rate.

The unit can either be set up via DIP switch control or via software control using either openGear's DashBoard™ platform or Simple Network Management Protocol (SNMP) using a third party Network Management System (NMS) program.

Note that when the IRT-6750-MEM is plugged in, or if a change to one of the system parameters takes place via the software control, on average it can take about 30 to 60 seconds to initialise into its selected mode.

### **ASI to TSoIP Converter Description of Operation:**

When configured as an ASI to TSoIP converter, the BNC connector on the rear assembly acts as an ASI input. The input ASI stream is first passed through a cable equaliser and then de-serialised. The packet size (188 or 204 bytes) is determined and then processed. If the IRT-6750-MEM has been configured to generate Forward Error Correction (FEC) packets, a FEC generator will create row and column FEC data. An IP embedder embeds the Transport Stream (TS) packets into IP packets, whence the resultant signal is transmitted through the Ethernet interface.

### **TSoIP to ASI Converter Description of Operation:**

When configured as a TSoIP to ASI converter, the BNC connector on the rear assembly acts as an ASI output. The unit accepts unicast and multicast streams over its Gigabit Ethernet port. The Ethernet interface checks the packets for corruption and correctness and sends them to an IP filter that selects the desired stream. Other IP packets are sent to a processor sub-system in order to support low level IP protocols like ARP (Address Resolution Protocol) and DHCP (Dynamic Host Configuration Protocol). From the IP filter the transport stream data enters a stream characteristic extractor. This will analyze the stream for specific characteristics like PCR (Program Clock Reference) information. With these characteristics the IRT-6750-MEM determines the bitrate for transmitting the stream to the output. An FEC reconstructor uses the FEC streams, if present, to reconstruct any missing packets.

Data is then stored in SDRAM (Synchronous Dynamic Random Access Memory). Jitter on the IP input may cause the late arrival of some IP packets. The memory is used as a buffer to de-jitter the stream. The size of the de-jitter buffer can be set via either the DashBoard™ software interface or via SNMP. The IP stream is then converted to an ASI Transport Stream (TS) with the correct bitrate. The TS contents are not affected by the IRT-6750-MEM.

## LED Indicators:

When the card is installed in a frame, the top 4 LEDs (2 rows of 2) of the board's front edge indicate when a connection has been established, whence all 4 LEDs illuminate Green. Whilst the board is configuring these 4 LEDs illuminate Red. Note that it may take 30 to 60 seconds for a connection to be fully established during which time the LEDs may alternate between Red and Green as the configuration settings are processed.

### ASI to TSoIP Converter LED Description:

The ASI LED indicates when a valid ASI input signal is detected whence it illuminates Green, else it will illuminate Red when an invalid or no signal is present.

The TSoIP LED illuminates Green when all the IP parameters are set correctly. If any of the IP parameters are incorrectly set, such as Destination IP Address Fail, this LED will illuminate Red. A Red flashing LED indicates that the ASI to TSoIP function is disabled, as set via Dashboard™ or SNMP control.

### TSoIP to ASI Converter LED Description:

The ASI LED indicates when an ASI output signal is present and ok whence it illuminates Green With no ASI signal available the LED is not illuminated.

The TSoIP LED illuminates Green when there are no problems detected within the TSoIP stream. Else if there is a problem with the processing of the TSoIP stream, then the LED will illuminate Red. A Red flashing LED indicates that the TSoIP to ASI function is disabled, as set via Dashboard™ or SNMP control.

## DIP Switch Control:

With the on board DIP switch SW1-1 = OFF, the IRT-6750-MEM is set up for DIP switch control. DIP switch settings can only be performed whilst the card is not installed in the frame. Adjusting the DIP switch settings whilst the card is powered on has no effect.

DIP switch SW1-5 sets whether the board is configured as either an ASI to TSoIP Transmitter (SW1-5 = OFF) or a TSoIP to ASI Receiver (SW1-5=ON).

A choice of 8 preset Card IP addresses, ranging from 192.168.1.200 to 192.168.1.207, is settable via DIP switches SW1-1, SW1-2 and SW1-3.

DIP switches SW1-6, SW1-7 and SW1-8 select a choice of 8 Destination IP addresses, ranging from 192.168.1.200 to 192.168.1.207, for use when the IRT-6750-MEM is set up for ASI to TSoIP (Transmitter) mode. The actual destination must have an IP address corresponding to 1 of these 8 Destination IP addresses. Note these 3 DIP switches are not used when the IRT-6750-MEM is set up for TSoIP to ASI (Receiver) mode.

DIP switches SW2-1, SW2-2 and SW2-3select a choice of 8 UDP port numbers ranging from 8000 to 8007. In the ASI to TSoIP Transmitter mode this corresponds "to" UDP port number; in the TSoIP to ASI Receiver mode this corresponds "from" UDP port number.

DIP switches SW2-4, SW2-5 and SW2-6 select the number of transport stream (TS) packets per IP packet that are transmitted in ASI to TSoIP Transmitter mode. These DIP switches have no effect in the TSoIP to ASI Receiver mode.

DIP switch SW2-7 selects whether the TSoIP output protocol is UDP or RTP when setup for ASI to TSoIP Transmitter mode, or whether to set the outgoing ASI packet size to match the incoming TSoIP stream or set to either 188 or 204 bytes as per the DIP switch SW2-8 position when setup for TSoIP to ASI Receiver mode.

DIP switch SW2-8 sets the packet size of the encoded TSoIP signal when in the ASI to TSoIP Transmitter mode, or the ASI output packet size, depending on SW2-7 position, when in the TSoIP to ASI Receiver mode.

**NOTE:** DIP switch quick configuration guides are available in the *Configuration* section of this manual.

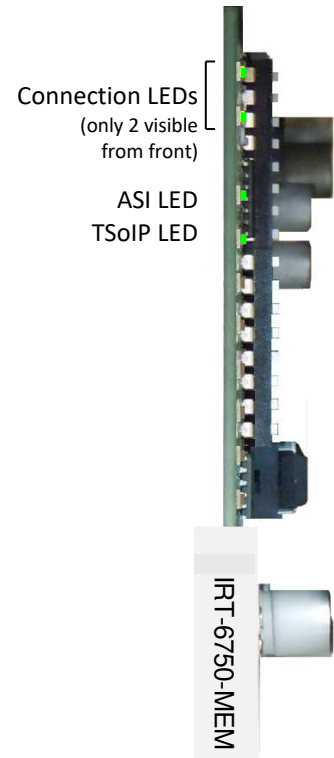

# IRT-6750-MEM

## Software Control:

With the on board DIP switch SW1-1 = ON, the IRT-6750-MEM is set up for either openGear's DashBoard™ software, or via a third party's Network Management System (NMS) control software using Simple Network Management Protocol (SNMP).

Through software it is possible to configure the IRT-6750-MEM with a greater flexibility than can be done via the pre-set DIP switch controls.

DashBoard™ and SNMP software controls are described separately in the *DashBoard™ Software Control* and *SNMP Software Control* sections of this manual.

## DashBoard™ SOFTWARE CONTROL

The DashBoard™ Control and Monitoring System is a free application designed for remote control and monitoring of the openGear® platform. This is a free application downloadable from the openGear® website ([www.opengear.tv](http://www.opengear.tv)). As such, configuration of the DashBoard™ program will not be described here. The DashBoard™ manual is also downloadable from the openGear® website.

### IRT-6750-MEM DashBoard™ Screenshots:

#### Basic Tree View:

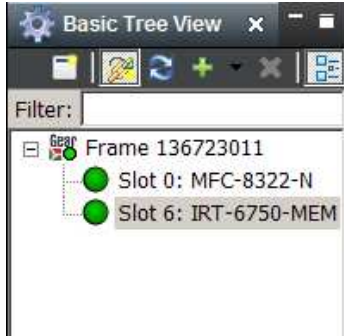

On the left the basic tree view shows the frame. With the tree structure expanded a list of cards within the frame is shown. In this example, slot position 6 is highlighted. All sections and tabs to the right of the basic tree view now relate to the card in slot position 6, in this case the IRT-6750-MEM. The name of the switcher, in this case IRT-6750-MEM, can be set under the Configuration TAB setting.

#### Product TAB:

Self explanatory. Note that the Product Alias field can be set under the Configuration TAB setting.

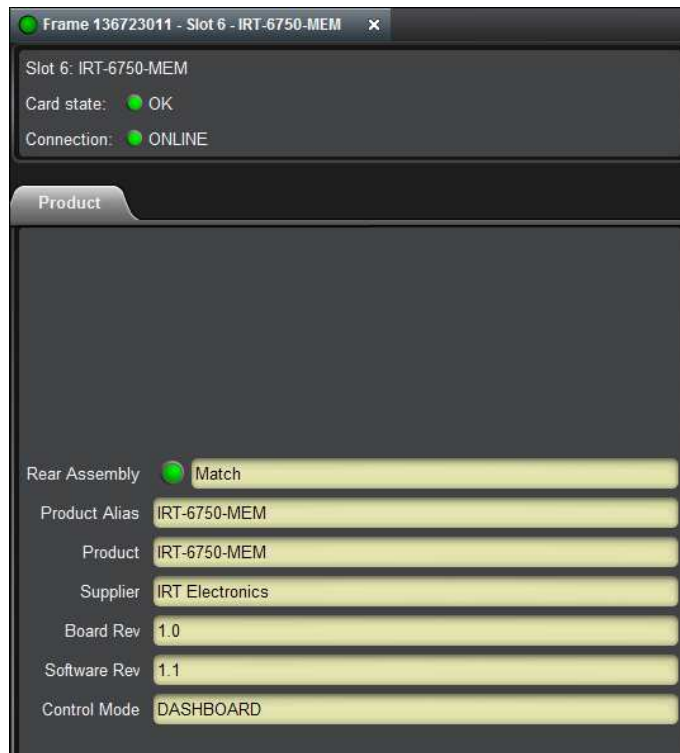

## Config TAB:

Under the Configuration TAB parameters such as Product Alias (name), the mode of operation (ASI to TSoIP or TSoIP to ASI), the card's own IP address, Subnet Mask and Gateway addresses can be user set. The card's own MAC address and SubBoard status are also reported.

Click computer mouse into the Product Alias field to change to new name, if desired.

The Mode field has a choice of 'ASI to TSoIP' or 'TSoIP to ASI' modes selectable via the down arrow to the right of the field.

A static IP address can be user set for the card or an IP address can be automatically set via the DHCP setting when connected to a DHCP server. Subnet Mask and Gateway addresses also need to be set. An understanding of Ethernet routing practices is required and assumed when setting these fields and therefore is not described in this handbook.

Note that if DIP switch SW1-1 has been set to the OFF position, these settings will only monitor the card's settings as set by the DIP switch control pre-set settings.

The screenshot displays the configuration interface for the IRT-6750-MEM device. At the top, there are three tabs: 'Config', 'ASI to TSoIP', and 'TSoIP to ASI'. The 'Config' tab is active. The interface is dark-themed and contains the following fields and controls:

- Product Alias:** A text input field containing 'IRT-6750-MEM'.
- Device:** A button labeled 'RESET'.
- SubBoard Settings:** A horizontal line separator.
- Network Data:** A button labeled 'Refresh'.
- Mode:** A dropdown menu currently set to 'TSoIP to ASI'.
- IP Address:** A text input field containing '192.168.1.200'.
- Subnet Mask:** A text input field containing '255.255.255.0'.
- Gateway:** A text input field containing '192.168.1.1'.
- Internet Protocol:** Two radio buttons, 'Static IP Address' (selected) and 'DHCP'.
- SubBoard:** A button labeled 'Reboot'.
- Mac Address:** A text input field containing '00:14:F4:05:85:22'.
- SubBoard Status:** A green indicator light and a text field containing 'Connected'.



## ASI to TSoIP TAB:

When the Mode field under the Configuration TAB has been set to ASI to TSoIP mode, the ASI to TSoIP TAB becomes active.

ASI to TSoIP mode can be enabled or disabled under the IP Transmit Settings section. The default state is enabled. Disabling will turn off the transmission over IP.

Forward Error Correction (FEC) conforming to SMPTE 2022 standard can also be enabled or disabled for use when the TSoIP Output Protocol has been set to RTP. FEC Columns (L) setting can be set from 1 to 20 bytes and the FEC Rows (D) setting can be set from 4 to 20 bytes. The maximum FEC size (LxD) is however limited to 100 bytes. Forward error correction allows a received signal to reconstruct itself if bits have been dropped in the transmission path. The higher the FEC the more correction can take place, however the more FEC applied results in more processing time and hence delay, or latency, of the received signal compared to the input signal. FEC is not applicable when the TSoIP Output Protocol has been set to UDP, whence the FEC setting should be disabled.

The Destination IP address of the receiver needs to be specified. If the Destination IP address cannot be found an error indication is shown in the Destination IP Status field. It is possible to set the Destination IP address field to a Multicast IP address for transmission to multiple destinations.

The UDP Port number to match that of the destination can be set from 0 to 65535.

From 1 to 7 transport packets can be generated per IP packet.

The TSoIP Output protocol can be set to either UDP or RTP encapsulation. RTP allows FEC support.

Time to Live is a counter that limits the lifespan of data in a network. Once the prescribed event count has elapsed, data is discarded. This prevents a data packet from circulating indefinitely in a network. Adjustable from 0 to 255.

The IP packet size can be set to 188 or 204 bytes in length or to match that of the input ASI signal selectable via the down arrow to the right of the field.

The ASI Input Status indicates when a valid ASI input has been connected. The TS rate in bits per second is also reported.

The screenshot displays the configuration interface for the ASI to TSoIP mode. It features several sections and fields:

- Config** (tabs): ASI to TSoIP, TSoIP to ASI
- ASI to TSoIP Data**: Refresh button
- IP Transmit Settings**:
  - ASI to TSoIP:  Enable  Disable
  - FEC Encoding:  Enable  Disable
  - FEC Columns (1...20): 1
  - FEC Rows (4...20): 4
  - Destination IP Address: 192.168.1.100
  - Destination IP Status: ● Destination IP Address Resolved
  - UDP Port (0...65535): 8000
  - TP per IP (1...7): 1
  - TSoIP Output Protocol:  UDP  RTP
  - Time to Live (0...255): 100
  - IP Packet Size: 188-Bytes (dropdown menu)
- ASI Input**:
  - ASI Input Status: ● Valid ASI Signal
  - Ts Rate (bps): 38764677

## TSolP to ASI TAB:

When the Mode field under the Configuration TAB has been set to TSolP to ASI mode, the TSolP to ASI TAB becomes active.

TSolP to ASI mode can be enabled or disabled under the IP Receive Settings section. The default state is enabled. Disabling will turn off the streaming of ASI.

If the unit is receiving a TSolP stream from a source that has been set up to unicast its Destination IP address to this cards IP address, then set the Addressing Method to Unicast. If receiving the TSolP stream from a multicast address, set the Addressing Method to Multicast and enter the Multicast IP Address in its corresponding field further below.

If the received signal contains Forward Error Correction (FEC), FEC Decoding can either be enabled or disabled. The number of FEC Columns and Rows received are reported in the subsequent fields. An 'FEC Columns 0' and 'FEC Rows 0' reported indicates that there is no FEC on the received stream.

The IP Jitter field is the time (in ms) reported that the card waits to receive late IP packets.

The UDP Port number at which the unit listens for the incoming TS. Can be set from 0 to 65535.

The IP to Output Delay field is a settable buffer from 1 to 9942ms. This creates a delay between the IP input to ASI output. The buffer size determines the amount of IP jitter removal from the incoming stream.

The Rate Estimation Mode allows a choice of four ways that the stream bitrate is estimated via the down arrow to the right of the field.

The output ASI packet size can be set to 188 or 204 bytes in length or to match that of the input TSolP signal selectable via the down arrow to the right of the field. Note that the TS Rate as reported under the ASI Output Settings section is the rate at 188 bytes packet size regardless whether the ASI packet size has been set to 204 bytes or not.

The screenshot shows the configuration interface for the TSolP to ASI tab. The interface is divided into several sections:

- TSolP to ASI Data:** Includes a 'Refresh' button.
- IP Receive Settings:**
  - TSolP to ASI:  Enable  Disable
  - Addressing Method:  Unicast  Multicast
  - FEC Decoding:  Enable  Disable
  - FEC Columns (0..20): 0
  - FEC Rows (0..20): 0
  - IP Jitter (ms): 100
  - UDP Port (0...65535): 8000
  - IP to Output Delay (1...9942ms): 100
  - Multicast IP Address: 0.0.0.0
  - TP per IP: 0
- Channel Status:** ● Channel Enabled, No Errors
- TSolP Input Protocol:**  UDP  RTP
- IP Packet Size:** 188-Bytes
- Ts Rate (bps):** 0
- PCR Present:** No PCRs Found
- Rate Estimation Mode:** Bitrate Estimated with PCRs when Available
- ASI Output Settings:**
  - ASI Packet Size: 188-Bytes
  - Ts Rate (bps): 0

## SNMP SOFTWARE CONTROL

Control via SNMP is possible via a third party Network Management System (NMS) provided the openGear® frame is fitted with a relevant Network Management card. In the case of the OG3-FR frame the MFC-8322-NS network management card is required for SNMP control. In the case of either the DFR-8310 or DFR-8321 frames either the MFC-8310-NS or MFC-8320-NS cards are required for SNMP control. Relevant frame MIBs and card MIB required to interface to NMS software - see I.R.T. Communications website ([www.irtcommunications.com](http://www.irtcommunications.com)) for MIB download.

### IRT-6750-MEM SNMP Functions:

The following SNMP functions are capable of being controlled and monitored by an NMS:

**irt6750MEMProductTable** A table containing the IRT-6750-MEM Alias and Revision information:

- productAlias - An indication of the Alias (Name) of this card.
- boardRev - An indication of the hardware (board) revision of this card.
- softwareRev - An indication of the software revision programmed into this card.

**irt6750MEMOutputsTable** A table containing the IRT-6750-MEM ASI to Rear Assembly information:

- rearassembly - An indication whether the card is inserted into the correct rear assembly or not.
  - (1) match: Card is inserted into correct rear assembly.
  - (2) mismatch: Card is inserted into incorrect rear assembly.

**irt6750MEMSettingsTable** A table containing the IRT-6750-MEM Reset and Control type Settings:

- reset - Reset control reboots the card.
  - (0) set1toReset: Instruction message that says writing a 1 to field will reset card.
  - (1) cardResetting: Card is currently resetting.
- control - An indication of the control settings made as per the PCB DIP switch setting.
  - (0) snmp: Card settings can be controlled via Dashboard™ or SNMP control.
  - (1) pcbSwitches: Card settings as per DIP switch settings only.

**irt6750MEMNetworkSettingsTable** A table containing the IRT-6750-MEM Network Settings:

- subBoardConnection - An indication of the connection status of the card to its sub-board.
- mode - An indication and control of whether the card acts as a transmitter or receiver.
  - (0) asi\_to\_TsolP: Transmitter mode – ASI to TSoIP mode.
  - (1) tsolP\_to\_ASI: Receiver mode – TsoIP to ASI mode.
- cardIPByte1 - An indication and control of the first byte of the card's IP address.
- cardIPByte2 - An indication and control of the second byte of the card's IP address.
- cardIPByte3 - An indication and control of the third byte of the card's IP address.
- cardIPByte4 - An indication and control of the fourth byte of the card's IP address.
- cardSubnetMaskByte1 - An indication and control of the first byte of the card's Subnet Mask.
- cardSubnetMaskByte2 - An indication and control of the second byte of the card's Subnet Mask.
- cardSubnetMaskByte3 - An indication and control of the third byte of the card's Subnet Mask.
- cardSubnetMaskByte4 - An indication and control of the fourth byte of the card's Subnet Mask.
- cardGatewayByte1 - An indication and control of the first byte of the card's Gateway address.
- cardGatewayByte2 - An indication and control of the second byte of the card's Gateway address.
- cardGatewayByte3 - An indication and control of the third byte of the card's Gateway address.
- cardGatewayByte4 - An indication and control of the fourth byte of the card's Gateway address.
- internetProtocol - An indication and control of the protocol used for setting addresses.
  - (0) static\_IP\_Address: Card given its own specific IP address as decided upon by user.
  - (1) DHCP: Card automatically assigned an IP address as per DHCP server.
- subBoardReboot - Sub-board needs to be rebooted for addresses to take effect.
  - (0) set1toReboot: Instruction message that says writing a 1 to field will reboot sub-board.
  - (1) Rebooting: Sub-board is currently rebooting.
- macAddress - An indication of the card's MAC address.

# IRT-6750-MEM

**irt6750MEMASItolIPSettingsTable** A table containing the IRT-6750-MEM ASI to TSoIP Settings:

asi_to_TsolP	- An indication and control of whether the ASI to TSoIP function is enabled or not. (0) disable: ASI to TSoIP function is disabled. (1) enable: ASI to TSoIP function is enabled.
fecEncoding	- An indication and control of whether Forward Error Correction is enabled or not. (0) disable: FEC is disabled. (1) enable: FEC is enabled.
fecColumn	- An indication and control of the number of columns in FEC encoding (1 – 20).
fecRow	- An indication and control of the number of rows in FEC encoding (4 – 20). <b>NOTE:</b> Number of FEC Columns x Number of FEC Rows ≤ 100.
destinationIPAddressByte1	- An indication and control of the first byte of the Destination's IP address.
destinationIPAddressByte2	- An indication and control of the second byte of the Destination's IP address.
destinationIPAddressByte3	- An indication and control of the third byte of the Destination's IP address.
destinationIPAddressByte4	- An indication and control of the fourth byte of the Destination's IP address.
destinationudpPort	- An indication and control of the destination UDP Port for the transport stream. <b>NOTE:</b> UDP Port settable from 1 to 65535.
transmitTPPerIP	- An indication and control of the number of Transport Packets transmitted per IP packet. <b>NOTE:</b> Number of TP per IP ≤ 7.
outputProtocol	- An indication and control of the encapsulation method used for the TSoIP signal. (0) UDP: User Datagram Protocol. (1) RTP: Real-time Transport Protocol (FEC can be used with RTP).
timeToLive	- An indication and control of the Time To Live (TTL) parameter of the IP packet. <b>NOTE:</b> TTL settable from 0 to 255.
transmitIPPacketSize	- An indication and control of the size of the IP packets to be generated. (0) 188ByteSize: Set IP packet size to 188 bytes. (1) 204ByteSize: Set IP packet size to 204 bytes. (2) sizeOfIncomingPackets: Set IP packet size to match that of incoming ASI signal.
asiStatus	- An indication of the status of the incoming ASI signal. (1) validASISignal: Valid ASI input signal detected. (2) noCarrierDetect: No input signal detected. (4) unlockedSignal: Invalid input signal is present. (8) inputRateBelowMinimum: Input ASI rate is less than the minimum allowed.
tsRate	- An indication of the transport stream rate of the incoming ASI signal.

**irt6750MEMIPtoASISettingsTable** A table containing the IRT-6750-MEM TSoIP to ASI Settings:

tsolP_to_ASI	- An indication and control of whether the TSoIP to ASI function is enabled or not. (0) disable: TSoIP to ASI function is disabled. (1) enable: TSoIP to ASI function is enabled.
addressingMethod	- An indication and control of whether the card is being directly sent to (unicast), or receiving its signal from a multicast address. (0) unicast: Card is being directly sent to based on the card's own IP address. (1) multicast: Card is receiving signal from a multicast IP address.
fecDecoding	- An indication and control of whether Forward Error Correction Decoding is enabled or not. (2) disable: FEC Decoding is disabled. (3) enable: FEC Decoding is enabled.
decodedFECColumns	- An indication of the number of columns in FEC decoding (0 – 20).
decodedFECRows	- An indication of the number of rows in FEC encoding (0 – 20).
udpPort	- An indication and control of the UDP Port of the incoming transport stream. <b>NOTE:</b> UDP Port settable from 1 to 65535.
delayIPtoOutput	- An indication and control of the delay in milli-seconds between the incoming TS and transmitting ASI signal. Adjustable from 1 to 9942. This is used for reducing the output jitter of the ASI stream.
multicastAddressByte1	- An indication and control of the first byte of the Multicast IP address (if applicable).
multicastAddressByte2	- An indication and control of the second byte of the Multicast IP address (if applicable).
multicastAddressByte3	- An indication and control of the third byte of the Multicast IP address (if applicable).
multicastAddressByte4	- An indication and control of the fourth byte of the Multicast IP address (if applicable). <b>NOTE:</b> Multicast IP Address can only be set when in the Multicast mode.
receiveTPPerIP	- An indication and control of the number of Transport Packets received per IP packet.
incomingProtocol	- An indication of the encapsulation method used for the incoming TSoIP signal. (0) UDP: User Datagram Protocol. (1) RTP: Real-time Transport Protocol.
receivePacketSize	- An indication of the size of the Transport Packets received.
bitRate	- An indication of the estimated bitrate (at 188 bytes) of the received Transport Stream.
rateEstimationMethod	- An indication and control of the method used to estimate the ASI TS rate. (0) usingPCRifPresent: Using Program Clock Reference (PCR) if present. (1) bitrateEstimationDisabledPacketSentWithDelay: Packets sent with delay. (2) bitRateEstimationWithoutPCRs: Estimated without the use of PCRs. (3) bitrateEstimationDisabledPacketSentWithoutDelay: Packets sent immediately.
transmitASIPacketSize	- An indication and control of the size of the ASI packets to be generated. (0) 188ByteSize: Set IP packet size to 188 bytes. (1) 204ByteSize: Set IP packet size to 204 bytes. (2) sizeOfIncomingPackets: Set ASI packet size to match that of incoming TSoIP signal.
transmitASITsRate	- An indication of the transport stream rate of the out-going ASI signal.

## MAINTENANCE & STORAGE

---

### Maintenance:

No regular maintenance is required.

Care however should be taken to ensure that all connectors are kept clean and free from contamination of any kind. This is especially important in fibre optic equipment where cleanliness of optical connections is critical to performance.

### Storage:

If the equipment is not to be used for an extended period, it is recommended the whole unit be placed in a sealed plastic bag to prevent dust contamination. In areas of high humidity a suitably sized bag of silica gel should be included to deter corrosion.

Where individual circuit cards are stored, they should be placed in antistatic bags. Proper antistatic procedures should be followed when inserting or removing cards from these bags.

## WARRANTY & SERVICE

---

Equipment is covered by a limited warranty period of three years from date of first delivery unless contrary conditions apply under a particular contract of supply. For situations when “**No Fault Found**” for repairs, a minimum charge of 1 hour’s labour, at IRT’s current labour charge rate, will apply, whether the equipment is within the warranty period or not.

Equipment warranty is limited to faults attributable to defects in original design or manufacture. Warranty on components shall be extended by IRT only to the extent obtainable from the component supplier.

### Equipment return:

Before arranging service, ensure that the fault is in the unit to be serviced and not in associated equipment. If possible, confirm this by substitution.

Before returning equipment contact should be made with IRT or your local agent to determine whether the equipment can be serviced in the field or should be returned for repair.

The equipment should be properly packed for return observing antistatic procedures.

The following information should accompany the unit to be returned:

1. A fault report should be included indicating the nature of the fault
2. The operating conditions under which the fault initially occurred.
3. Any additional information, which may be of assistance in fault location and remedy.
4. A contact name and telephone and fax numbers.
5. Details of payment method for items not covered by warranty.
6. Full return address.

For situations when “**No Fault Found**” for repairs, a minimum charge of 1 hour’s labour will apply, whether the equipment is within the warranty period or not. Contact IRT for current hourly rate.

Please note that all freight charges are the responsibility of the customer.

The equipment should be returned **to the agent who originally supplied the equipment** or, where this is not possible, to IRT directly. Details of IRT’s direct address can be found at I.R.T. Communications’ website.

Web address: [www.irtcommunications.com](http://www.irtcommunications.com)

Email: [sales@irtcommunications.com](mailto:sales@irtcommunications.com)